

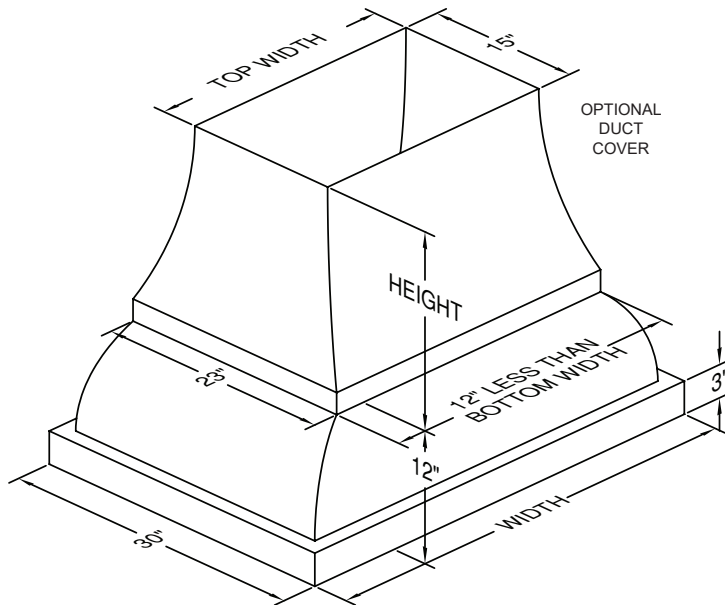

## DESIGNER SERIES ISLAND RANGE HOOD

JCIH/A1 Equipped with LED lighting. Not available with heat lamps. Shown with optional duct cover (sold separately). Optional duct covers available in standard and custom sizes.



### Recommended Mounting Height\*

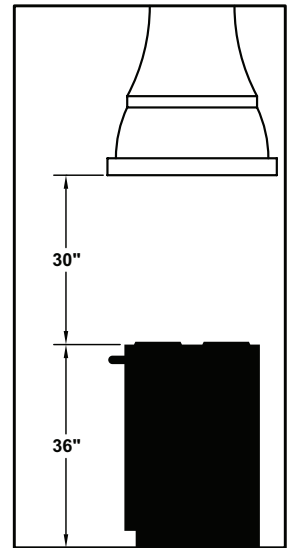

\*Recommended mounting height is for optimum performance.

### Connection Diagram (36" - 54" Widths)

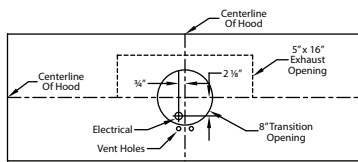

**550 CFM T200 Dual Blower (Top View)**

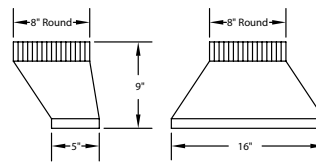

**VP565 Transition (Included)**

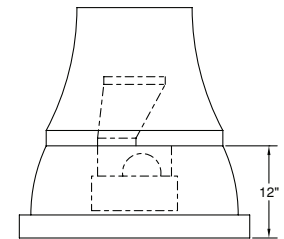

**Transition Installed (Side View)**

### Connection Diagram (48" - 66" Widths)

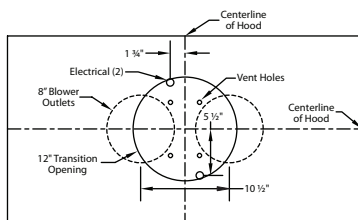

**1100 CFM T400 Cluster Blower (Top View)**

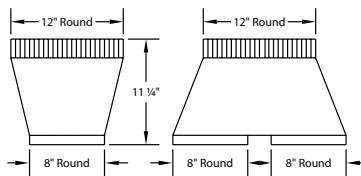

**VP564 Transition (Included)**

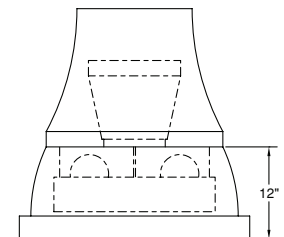

**Transition Installed (Side View)**

### Electrical/Mechanical Specifications For Blower Units

Model	Volts	Amps	Hz	RPM	CFM SP@0.0"	Equivalent CFM*	CFM SP@0.1"	CFM SP@0.2"	CFM SP@0.3"	Minimum Round Duct Size	Sones#
T200 Island Dual	115	4.0	60	1550	550	900	507	471	431	8" (50 in. <sup>2</sup> )	6.0
T400 Island Cluster	115	7.5	60	1550	1100	1800	998	855	774	12" (113 in. <sup>2</sup> )	6.4

Hood is available with LED lights (one in each corner).

\* Because the Magic Lung<sup>®</sup> blower uses centrifugal filtration rather than conventional baffle or mesh filters, the Magic Lung<sup>®</sup> blower can handle cooking equipment with higher cubic feet per minute (CFM) requirements and can deliver equivalent CFM much more efficiently than other filtration systems. When comparing the Magic Lung<sup>®</sup> with other blower units made by other manufacturers, use the "Equivalent CFM".

# Ratings in accordance with the Standard Test Code by the Energy Systems Laboratory of the Texas Engineering Experiment Station.

SPECIFICATIONS SUBJECT TO CHANGE WITHOUT NOTICE Rev. 0516A

