



**Read and Save These Instructions**  
**All Hoods Must Be Installed By A Qualified Installer**

# **INSTALLATION INSTRUCTIONS**

## **PDH7-K WALL MOUNT HOOD**

**Read All Instructions Thoroughly Before Beginning Installation**

**WARNING - TO REDUCE THE RISK OF FIRE, ELECTRIC SHOCK, OR INJURY TO PERSONS, OBSERVE THE FOLLOWING:**

- A. Installation work and electrical wiring must be done by qualified person(s) in accordance with all applicable codes and standards, including fire-rated construction. Switch power off at service panel and lock the service disconnecting means to prevent power from being switched on accidentally during installation.**
- B. When cutting or drilling into wall or ceiling, do not damage electrical wiring and other hidden utilities.**
- C. Ducted fans must always be vented to the outdoors.**
- D. Sufficient air is needed for proper combustion and exhausting of gases through the flue (chimney) of fuel burning equipment to prevent back drafting. Follow the heating equipment manufacturer's guideline and safety standards such as those published by the National Fire Protection Association (NFPA), and the American Society for Heating, Refrigeration and Air Conditioning Engineers (ASHRAE), and local code authorities.**
- E. ASHRAE residential ventilation standard 62.2 limits exhaust fans (total) to a maximum of 15 CFM per 100 square feet of occupiable space, unless a back drafting test is performed or make-up air is provided. Consult a local HVAC engineer for make-up air evaluation.**

**WARNING - TO REDUCE THE RISK OF FIRE, USE ONLY METAL DUCTWORK**

# Vent-A-Hood®

## Ducting Do's and Don'ts

### General Requirements

- Observe local codes regarding special duct requirements and placement of duct against combustibles.
- Using Vent-A-Hood transitions (back page) will ensure proper efficiency.
- Using Vent-A-Hood roof jacks or wall louvers (back page) will ensure proper efficiency.
- Where possible, seal joints with duct tape.
- The hood must be ducted to the outdoors without restrictions.

### Blower Requirements

- The K250 blower unit requires 7" round duct or equivalent (38.5 square inches).

Blower	Duct Dize	Sq. Inch Area	Vent-A-Hood Transition
K250	3 1/4" x 10" or equivalent	38.5 sq. in.	VP521 (Optional)

### Ducting Requirements

- NEVER reduce the duct size.
- Do not use flexible or corrugated duct. This type of duct will restrict airflow and reduce performance.
- Only use smooth, galvanized, metal duct.
- Make the duct run as short and as straight as possible with as few turns as possible.
- Avoid sharp-angled turns. Instead, use smooth, gradual turns such as adjustable elbows or 45 degree angled turns.
- For duct runs over 20 feet, increase the duct diameter by one inch for every ten feet of duct.
- A 90 degree elbow is equal to 5 feet of duct.

### Termination Requirements

- Airflow must not be restricted at the end of the duct run.
- A wall louver or roof jack is required for each duct run.
- Every wall louver or roof jack must include a gravity damper to prevent back drafts.
- Do not use screen wire or spring-loaded doors on wall louvers or roof jacks.
- Do not terminate venting into an attic or chimney.

YES



Smooth Duct

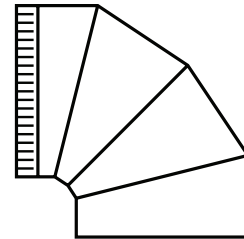

Smooth Gradual Turn

NO

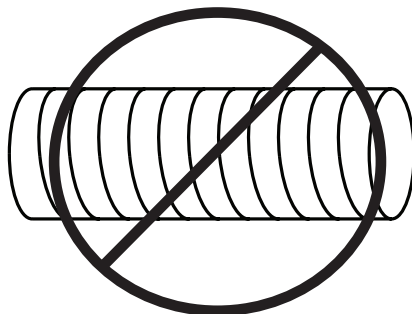

Flexible Duct

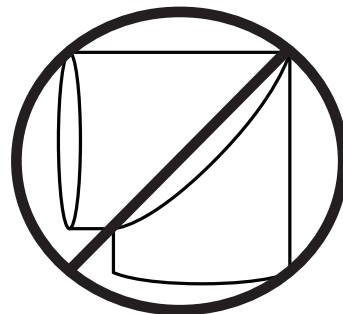

Sharp Angled Turns

# Vent-A-Hood®

## Installation Details

- 1) Read all instructions thoroughly before beginning installation. Note: These instructions apply to standard hoods only. Custom hoods may require additional specification consideration.
- 2) When installing a PDH7-K wall mount hood, it is recommended that the bottom edge of the hood be located no more than 24" above the cooking surface for optimum performance.

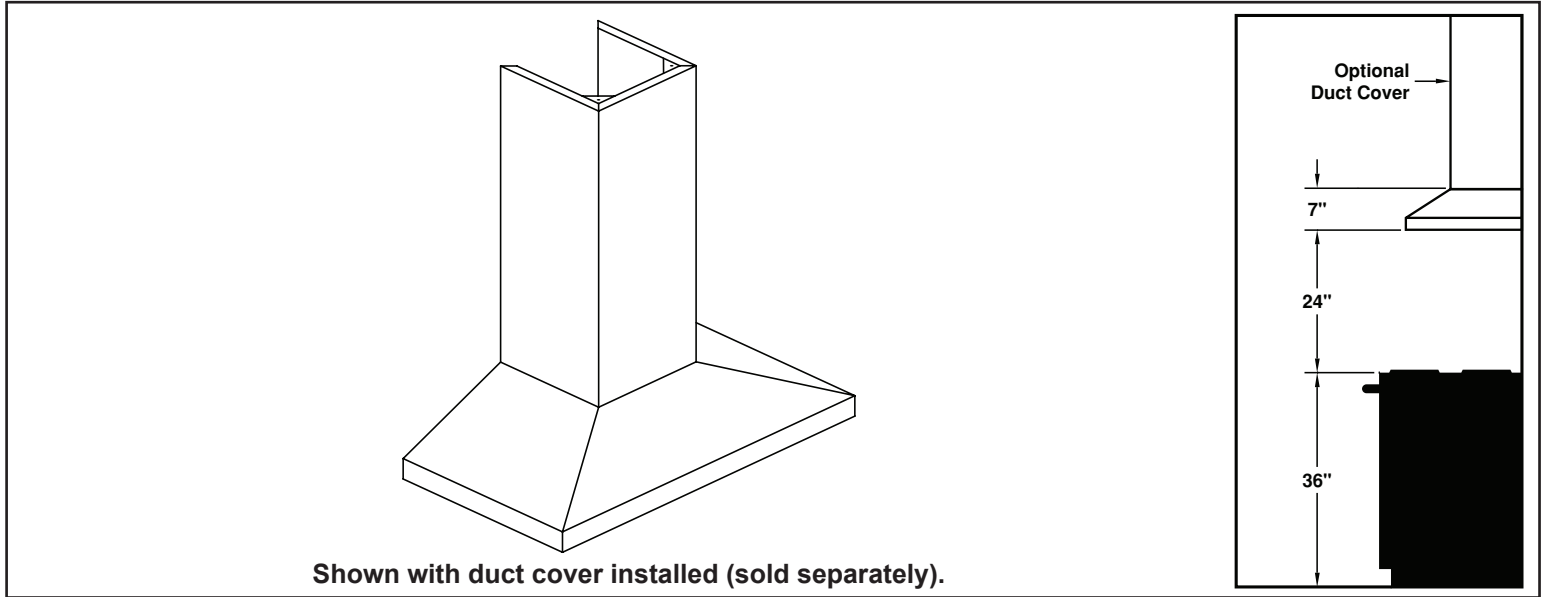

- 3) IF THE HOOD IS TO BE "BACK VENTED", PROCEED DIRECTLY TO STEP 4.

Install the duct from the outside of the home to the ceiling over the exhaust outlet of the hood. The end of the duct should extend 1" below the ceiling. Consult the connection diagram (below) for further details on exhaust outlet placement.

Use duct tape to seal all joints. A complete listing of available Vent-A-Hood ducting materials is provided on the back page of this instruction sheet.

Transition height: 3 1/4" x 10" duct will connect directly to the exhaust outlet of the hood. Optional VP521 transition to 7" round (sold separately) is 7 1/2" tall.

### Connection Diagram

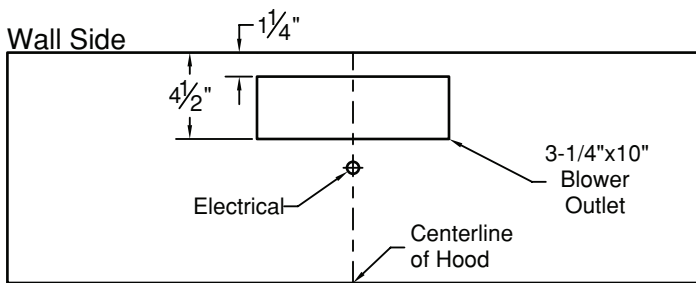

**250 CFM K250 Blower  
(Top View)**

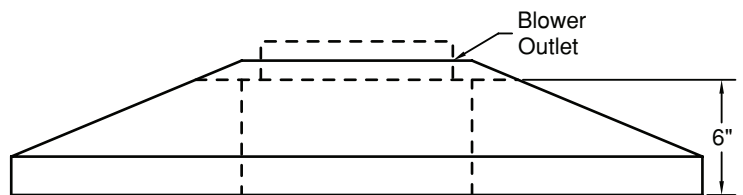

**(Front View)**

- 4) Remove the hood from its packaging and place the back of the hood on the floor or countertop in front of the wall where it will hang.

# Vent-A-Hood®

## Installation Details Continued

**Warning: Make sure power is off and locked at the service disconnecting means on the service panel during installation.**

- 5) Install an appropriate 1/2" UL listed electrical wire clamp through the electrical strap on the top of the hood deck. Install electrical wiring from the electrical panel to the hood location.

Model	Volts	Amps	Hz	RPM	CFM SP@0.0"	Equivalent CFM*	CFM SP@0.1"	CFM SP@0.2"	CFM SP@0.3"	Minimum Round Duct Size	Sones#
K250 (Top Vent)	115	3.5	60	1550	250	375	223	220	190	7" (38 in. <sup>2</sup> )	7.4

\* Because the Power Lung® blower uses centrifugal filtration rather than conventional baffle or mesh filters, the Power Lung® blower can handle cooking equipment with higher cubic feet per minute (CFM) requirements and can deliver equivalent CFM much more efficiently than other filtration systems. When comparing the Power Lung® with other blower units made by other manufacturers, use the "Equivalent CFM".

\* Ratings in accordance with the Standard Test Code by the Energy Systems Laboratory of the Texas Engineering Experiment Station.

- 6) Insert the electrical wire through the electrical wire clamp allowing 3" to 4" of wire for hookup. Tighten the electrical wire clamp.
- 7) From above the hood, using UL listed wire nuts, attach the "neutral" wire to the white lead, the "hot" wire to the black lead, and the ground wire to the green lead.

**Warning: Do not operate hood without proper ground connection.**

- 8) Remove the duct cover from its packaging. Remove the duct cover mounting screws from the top of the hood. Place the duct cover into the top of the hood. Attach the duct cover to the hood with the screws previously removed.
- 9) Lift the hood and duct cover assembly to the location on the wall where it will be installed and lightly mark the wall with a short horizontal mark along the bottom edge of the hood.
- 10) Remove the hood and duct cover assembly from the wall. On the back side of the hood, measure the distance between the bottom edge of the hood and the top edge of the wood mounting strip. Measure this distance above the horizontal line made in Step 9 and lightly mark the wall with a level, horizontal line. Measure where the center (left to right) of the hood will be and mark the upper, horizontal line on the wall with a short, vertical centerline.
- 11) Remove the screws inside the top of the back of the hood that retain the wood mounting strip that is recessed in the mounting channel. Remove the wood mounting strip from the back of the hood and place the top edge of the strip on the upper, level horizontal line on the wall. Referencing the vertical centerline from Step 10, place the mounting strip so it is centered (left to right) on the wall in the space where the hood will be located. Drill pilot holes in the wood mounting strip to prevent splitting. Using proper hardware, attach the mounting strip to at least two wall studs.
- 12) FOR BACK VENTING APPLICATIONS ONLY. IF NOT BACK VENTING PROCEED DIRECTLY TO STEP 13.

**Note:** Wall studs may interfere with back venting applications. Additional framing may be required. It is necessary to cut a duct access hole in the wall prior to installing the hood. Starting 7/8" above the top of the mounting strip, cut a hole 3 1/2" high x 10 1/4" wide centered on the hood centerline (see diagram at right). Install the duct from the outside of the home to the opening in the wall. Use duct tape to seal joints.

**Back Venting Cut Out Diagram**

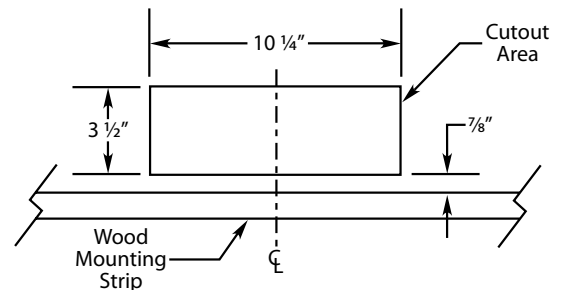

- 13) Hang the hood on the mounting strip by aligning the channel at the top of the back of the hood over the wood mounting strip on the wall. While holding the hood in place, mark locations on the mounting strip through the two mounting holes in the channel at the top of the hood. Remove hood and drill 3/32" pilot holes at the center of marks in the wood strip to prevent splitting.



## Installation Details Continued

**14) FOR BACK VENTING APPLICATIONS ONLY. IF NOT BACK VENTING PROCEED DIRECTLY TO STEP 16.**

Place the back vent elbow (Vent-A-Hood part number VP559) on the top of the hood. The elbow should be placed on the inside the collar of the exhaust outlet. Use duct tape to seal joints. While securing the slack in the wire, lift the hood up to the wall and hang the hood on the mounting strip, taking care to properly align the duct connection between the elbow on the hood and the duct in the wall. Secure the hood to the mounting strip by installing the screws (previously removed from the strip in Step 11) into the pilot holes drilled in Step 13. **SKIP STEPS 15 AND 16. PROCEED DIRECTLY TO STEP 17.**

**15) Cut a piece of duct of sufficient length to meet the duct in the ceiling allowing room for the transition (if applicable). If the VP521 transition is used, cut the duct to reach the transition outlet plus 1". This will allow the transition to engage 1" inside of the duct. One end of the duct must be crimped to fit inside the duct in the ceiling. Insert the non-crimped end over the transition or into the exhaust collar on top of the hood and seal with duct tape.**

**16) While securing the slack in the wire, lift the hood up to the wall and hang the hood on the mounting strip, taking care to properly align the duct connection between the hood and the duct in the ceiling or wall. Secure the hood to the mounting strip by installing the screws (previously removed from the strip in Step 11) into the pilot holes drilled in Step 13.**

**17) Refer to the Owner Maintenance Guide Operating Instructions for proper hood operation. Test all blower and light functions to ensure they are operating properly.**

# VENTING

# Vent-A-Hood®

# ACCESSORIES

WALL LOUVER

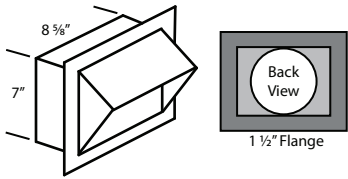

MODEL VP527 DIM 7" Round

RECTANGULAR WALL LOUVER

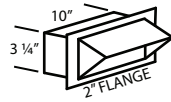

MODEL VP560 DIM 3 1/4" x 10"

LOW PROFILE ROOF JACK (MAXIMUM 4/12 PITCH)

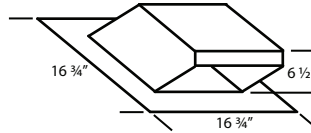

MODEL VP540 DIM 7" Round

LOW PROFILE ROOF JACK (MINIMUM 4/12 PITCH)

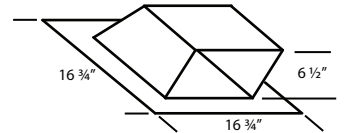

MODEL VP540-HP DIM 7" Round

ADJUSTABLE ELBOW

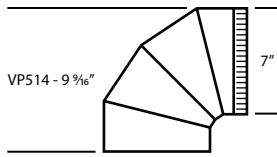

MODEL VP514 DIM 7" Round

3 1/4" x 10" TO 7" TRANSITION

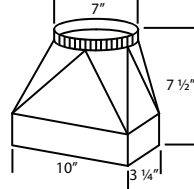

MODEL VP521 DIM 3 1/4" x 10" to 7"

3 1/4" x 10" BACK VENT ELBOW

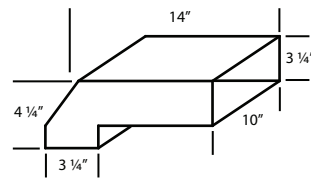

MODEL VP559 DIM 3 1/4" x 10"

ROUND DUCT PIPE



MODEL VP501 DIM 7" Round

3 1/4" RECTANGULAR DUCT PIPE

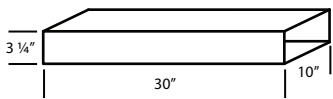

MODEL VP504 DIM 3 1/4" x 10"